

BE

Befestigungselemente

Befestigungselemente

BE.01 Klemme mit Schraube NAAMS

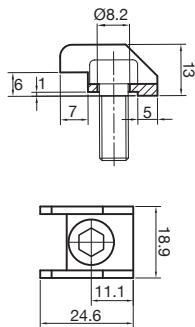
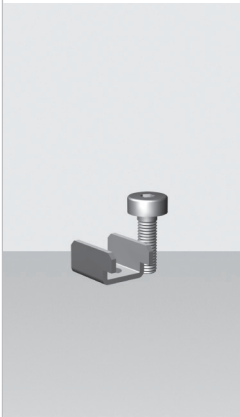

| | |
|--------------|----------|
| BE.01 | M |
| BE.01 | M8 |

BE.02 Klemme mit Schraube

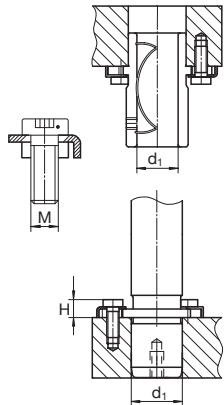

| | | |
|--------------|----------|----------|
| BE.02 | M | H |
| BE.02 | M6 | 12,5 |

BE.03 Klemme

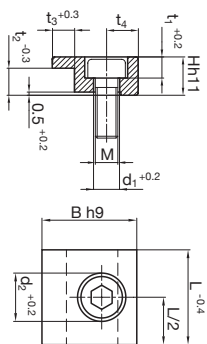
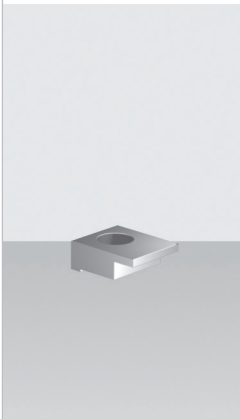

| | | | | | | | | | | |
|--------------|----------|-----------|----------|----------|----------|-----------|-----------|-----------|-----------|-----------|
| BE.03 | M | t2 | B | L | H | d1 | d2 | t1 | t3 | t4 |
| BE.03.01 | M6x16 | 6,3 | 20 | 20 | 10 | 7 | 11 | 7 | 5 | 7,5 |
| BE.03.02 | M10x20 | 10 | 32 | 32 | 16 | 11,5 | 17,5 | 11,5 | 10 | 11 |
| BE.03.03 | M10x20 | 6 | 32 | 32 | 16 | 11,5 | 17,5 | 11,4 | 10 | 11 |

BE.04 Haltescheibe mit Schraube

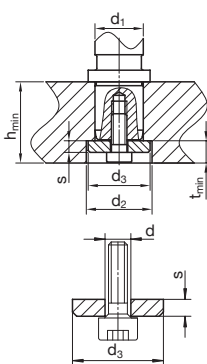
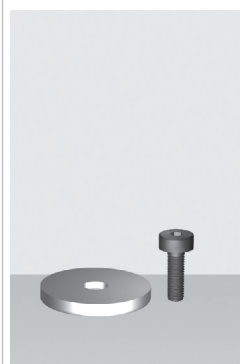

| | | | | | | | |
|--------------|-----------------|-------|-------|-------|-------|-------|------|
| BE.04 | BE.04.d1 | | | | | | |
| d1 | 19/20 | 24/25 | 30/32 | 38/40 | 48/50 | 60/63 | 80 |
| d2 | 27 | 34 | 42 | 52 | 62 | 72 | 95 |
| d3 | 25 | 32 | 40 | 50 | 60 | 70 | 93 |
| d | 9 | 9 | 9 | 9 | 9 | 9 | 13 |
| s | 6 | 6 | 6 | 6 | 6 | 6 | 12 |
| t/min | 11,5 | 11,5 | 11,5 | 11,5 | 11,5 | 11,5 | 20,5 |
| h/min | 35 | 42 | 49 | 49 | 59 | 59 | 80 |

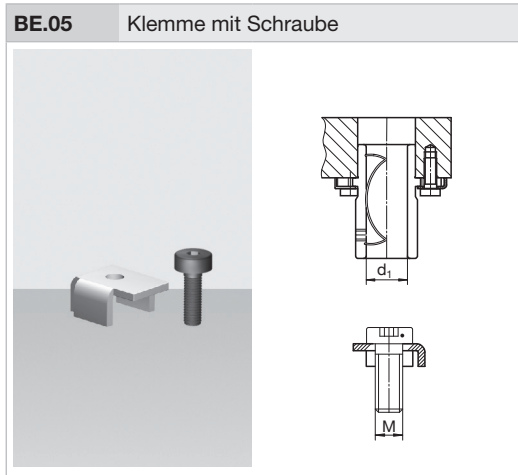

| BE.05 | | |
|-------|----|------|
| | M | H |
| BE.05 | M6 | 12,5 |